







Title: <i>Block Diagram</i>	Version: <i>1.0.0</i>	  <small>Solutions pour la société numérique</small>
Board: <i>Zest_Module_LoRa169</i>	Size: <i>A4</i>	
Project: <i>6TRON</i>	Sheet: <i>1 of 3</i>	
Author: <i>SGA</i>	Date modified: <i>23/11/2021</i>	

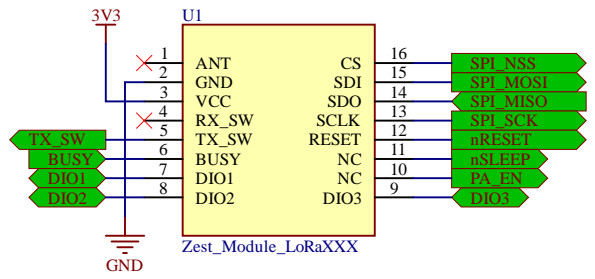

Title: <i>Interconnect</i>		Version: <i>1.0.0</i>		
Board: <i>Zest_Module_LoRa169</i>		Size: <i>A4</i>		
Project: <i>6TRON</i>		Sheet: <i>2 of 3</i>		
Author: <i>SGA</i>		Date modified: <i>23/11/2021</i>		

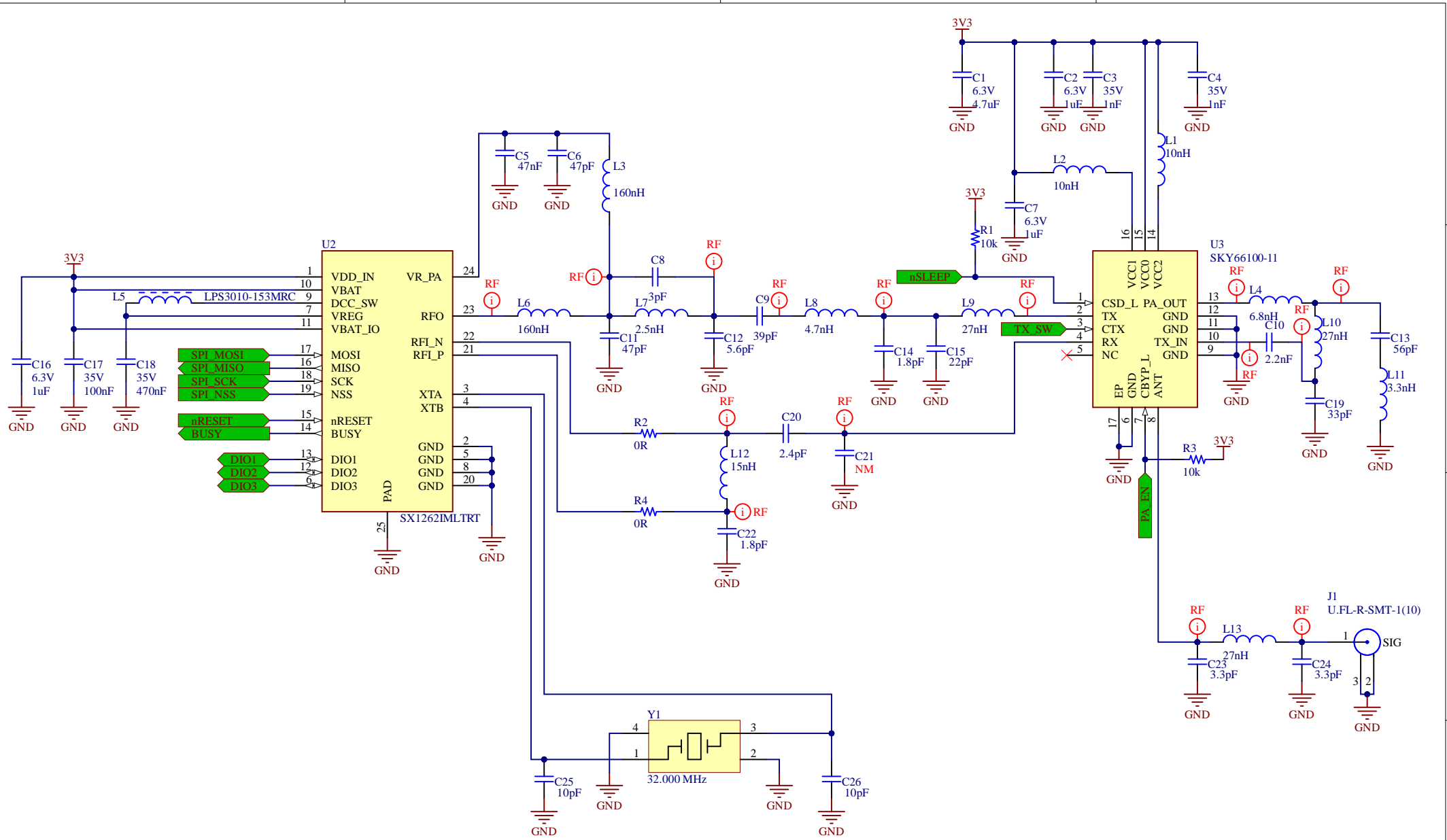

Title: <i>Radio</i>	Version: <i>1.0.0</i>	 CATIE Solutions pour la société numérique
Board: <i>Zest_Module_LoRa169</i>	Size: <i>A4</i>	
Project: <i>6TRON</i>	Sheet: <i>3 of 3</i>	
Author: <i>SGA</i>	Date modified: <i>29/11/2021</i>	

